

EVLUMA OMNIMAX®

LED DECORATIVE LUMINAIRE REPLACEMENT LAMP
40W, 70W OR 100W - REPLACES HID BULBS 100-175W

OMNI-40
OMNI-70
OMNI-100



CERTIFICATION DATA
UL 1598 & UL1598C MET
ANSI C136.31 3G Level 2
Vibration Bridge/Overpass

ENERGY DATA
120-277 VAC 50/60hz
Power Factor >98%
THD <18% at 120 VAC
-40°C Min Ambient Temp
40°C Max Ambient Temp

SHIPPING DATA
Single Unit: 2 lbs (0.9 kg)
LTL PAL Qty: 180 units, 385 lbs (277 kg)

DESCRIPTION

The first truly omnidirectional LED replacement lamp for HID decorative outdoor light fixtures. Emulates the light center and pattern of the legacy HID bulb. This easy to install, screw-in lamp is self-ballasted and offers exceptional energy and maintenance savings. Available in multiple color temperatures to brighten and revitalize or re-create a historic gaslight glow. With Evluma's Photocontrol Failsafe™ built-in, never again roll a truck to replace a failed photocontrol. OmniMax Premium is compatible with ConnectLED™. A Standard version is available for applications where connectivity is not required.

Construction & Finish

White Valox DR48 molded resin.
Flexible PCB light engine wrapped around aluminum heatsink.

Optical (lens)

Revolutionary molded silicone lens with matte finish over radial LED light source for maximum light diffusion and no discoloration.

Electrical

Evluma proprietary dimmable driver. 120-277 VAC 60 Hz. High capability surge protection for 20kV/10kA per IEEE/ANSI C62.41.2-2002. Location Category C-High. 100W tested to IEEE/ANSI C136.2:2018.

Thermal Management

Like all Evluma products, LED life is assured by thermal management protection circuitry that controls current levels to the LEDs based on temperature. The OmniMax uses a network of temperature compensating components paired with a custom light engine and housing design to maximize cooling and maximize lumen output. The OmniMax also uses a brushless fan with an accelerated life of >90,000 hours.

Installation

The OmniMax is an easy-to-install, screw-in replacement lamp for HID light sources. Wiring around, or removing the legacy ballast is required prior to permanent installation. Suitable for damp locations within an enclosed luminaire.

Light-weight design suitable for horizontal and vertical installation.

Lumen Maintenance

L70 (10,000) >60,000
LM at 10,000 hours = 97%
LM at 100,000 hours = 80%

L70 (TM-21) >100,000

LM 80 and ISTMT available at www.evluma.com
TM 21 calculations available upon request.

Warranty

Ten-year warranty.
Visit www.evluma.com/products/omnimax-warranty/

EVLUMA OMNIMAX®

LED DECORATIVE LUMINAIRE REPLACEMENT LAMP
40W, 70W OR 100W - REPLACES HID BULBS 100-175W

OMNIMAX STANDARD (option) vs. PREMIUM

Evluma offers the OmniMax in two basic configurations, Standard and Premium. All configurations offer the same electrical performance, lumen maintenance and warranty.

STANDARD

Beautiful light, energy savings, easy install, low maintenance; all this comes standard with every OmniMax and sometimes ...that's all you need.

Standard

Order the Standard option if your lights run on a controlled circuit or you have no need for Photocontrol Failsafe. Standard models do not contain Bluetooth and are not compatible with ConnectLED. Standard models are not eligible for qualification by the DLC.

PREMIUM

OmniMax Premium includes Evluma's innovative solutions for smart, connected lighting. Key features include:

Photocontrol Failsafe™

First developed for the AreaMax, OmniMax Premium ships with Photocontrol Failsafe built-in, eliminating the need to replace failed photocontrols and saving truck-rolls. OmniMax Photocontrol Failsafe requires the use of a fail-on photocontrol. For fixtures with no photocontrol OmniMax Standard is an option.

ConnectLED™

OmniMax Premium is compatible with ConnectLED. Walk-by programming for each bulb without removing refractor. Communicate with each individual lamp up to 100 feet from the pole to wirelessly dim, control or disconnect. ConnectLED is available as an Apple or Android app. Sold separately.

EVLUMA OMNIMAX®

DIMENSIONS

SIZE SIMILAR TO HID BULB

Compact, custom electronics matched with a novel, high-power light engine make the self-ballasted OmniMax similar in size to an HID bulb and dramatically smaller than LED 'corn cobs' of comparable wattage. This equivalent size and radial light engine maximizes existing fixture optics.

3.4 in
(8.64 cm)

OmniMax vs Common HID Sizes Comparison (Inches)

OmniMax ME	6.76 L x 3.4 D 17.18 cm x 8.64 cm
OmniMax MO	7.29 L x 3.4 D 18.5 cm x 8.64 cm
100W MH ME	5.5 L x 2.125 D
150W MH MO	8.5 L x 3.5 D
100W HPS ME	5.5 L x 2.125 D
150W HPS ME	5.75 L x 2.25 D
100W HPS MO	7.5 L x 3 D
150W HPS MO	7.5 L x 3 D
200W HPS MO	9.5 L x 2.5 D
100W MV MO	7.5 L x 3 D

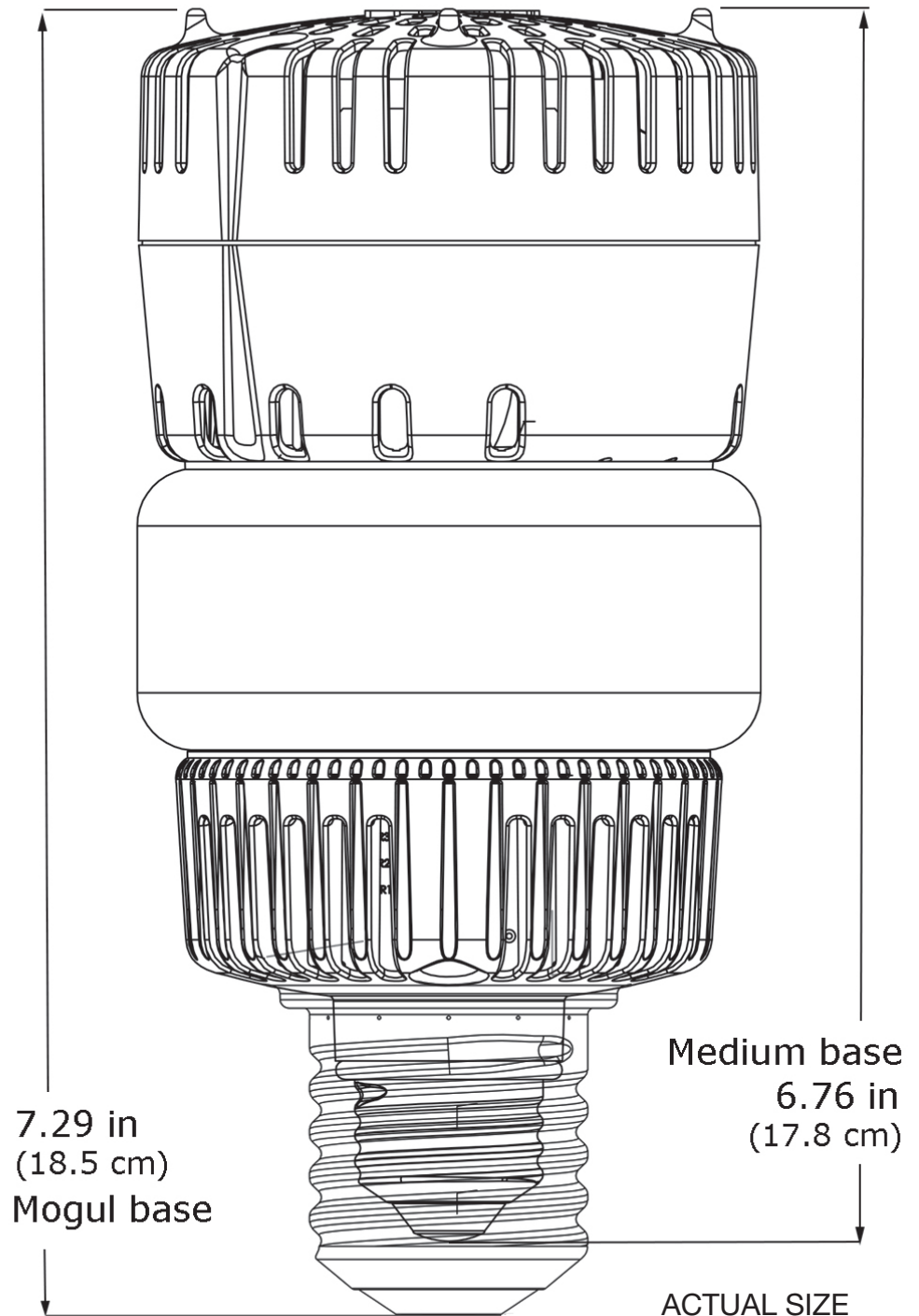

EVLUMA OMNIMAX®

ORDERING INFORMATION
 SAMPLE NUMBER: OMNI-70-5K-MO

Product Family	Watts (nom)	CCT	Base	Option	CRI	Lumens*	LED mA	Lm/W
40W LED (Recommended to replace up to 100W HPS / 150W MH)								
OMNI	40	2K = 2000K 22 = 2200K 27 = 2700K 3K = 3000K 4K = 4000K 5K = 5000K	ME=Medium MO=Mogul	STD = Standard Standard ships without Bluetooth or Photocontrol Failsafe built-in. STD models do not qualify for DLC.	>80	>3800 >4200 >5300 >5400 >5600 >5700	60 mA	>93 >97 >135 >138 >143 >145
70W LED (Recommended to replace up to 150W HPS / 175W MH)								
OMNI	70	2K = 2000K 22 = 2200K 27 = 2700K 3K = 3000K 4K = 4000K 5K = 5000K	ME=Medium MO=Mogul	STD = Standard Standard ships without Bluetooth or Photocontrol Failsafe built-in. STD models do not qualify for DLC.	>80	>5900 >6600 >8500 >8700 >9000 >9100	105 mA	>87 >92 >122 >125 >130 >132
70W LED (Recommended to replace up to 150W HPS / 175W MH)								
OMNI	100	2K = 2000K 22 = 2200K 27 = 2700K 3K = 3000K 4K = 4000K 5K = 5000K	ME=Medium MO=Mogul	STD = Standard Standard ships without Bluetooth or Photocontrol Failsafe built-in.	>80	>7675 >8125 >10650 >11225 >11650 >11800	138 mA	>75 >80 >108 >110 >115 >115

All OmniMax available in ME or MO configurations.
 Not all product variations listed on this page are DLC qualified.
 Only MO base products are accepted for DesignLights Consortium qualification <https://www.designlights.org/search/>

* Source Lumens

ACCELERATED LIFE TEST FOR OMNIMAX FAN

OMNI Fan Life at 40°C Continuous Ambient Conditions (Outdoors) = > 90,000 hrs

PHOTOMETRY

View complete IES files at www.evluma.com/products/omnimax

Photometric distribution at 70W 4K

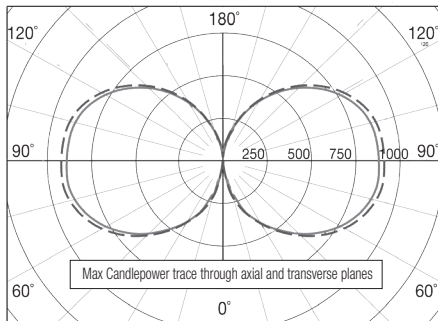

UL Test Report 12914541.07
 Source Lumens 9085 130 lm/W
 Delivered lumens and distribution may be modified by secondary optics.

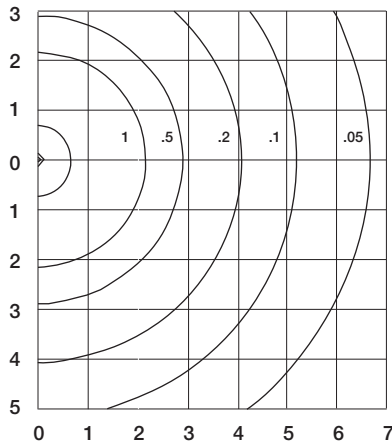

Isofootcandle plot
 Mounting Height = 8 ft (2.44m)