

ROADMAX[®] RX1

Evluma's Next Generation Roadway Luminaire
LED ROADWAY LIGHTING

Applications:

Residential streets &
local roadways, parking lots,
campuses, industrial parks.



RX1 Wattage Range: 30-100W

RX1 Lumen Range: 3,030-13,000 lumens

RoadMax RX1 delivers high-performance roadway distributions coupled with exceptional glare control. This sleek, utility-grade luminaire is easily configurable to meet a multitude of application requirements.

Replaces 70W-200W HID

The RoadMax RX1 is a single light engine luminaire with a lumen output ranging from 3,030 – 13,000 lumens and wattages ranging from 30 – 100 watts. Lumen output and wattage can be changed in the field through your choice of optional manual or wireless controls.

Construction & Finish

Cast aluminum housing with TGIC-free, polyester powder-coat in a variety of colors. Hinged tool-less access panel for wiring access. 2-bolt tenon clamp accepts 2" or 1-1/4" diameter arm. Step adjustment of +/- 5° tilt and integral bubble level built-in. Removable wildlife shield. Coastal version with enhanced hardware available meeting 3000-hour salt spray requirements.

Thermal Protection

Solid aluminum housing provides excellent passive cooling for all electronics. LED & driver life is ensured by thermal management protection that limits current levels to the LEDs based on system temperature. Luminaire is rated for full performance at -40°C min – 50°C max ambient temperature.

Lumen Maintenance

L70 (10,000) >55,000
L90 (10,000) >55,000
L70 (TM21) >100,000

LED & Optical

High-efficacy LEDs with color temperature options of 2700 – 5000 Kelvin and CRI > 70. High-performance Type II, Type III, and Type V primary borosilicate optics rated at IP66. Factory or field-installable secondary lens available on all optics for managing glare while achieving superior pole spacing. All configurations are Zero Uplight (U0 BUG). Field-installable light trespass shields are available.

Electrical

120-277 VAC 60 Hz auto-adjusting. Driver is Evluma-proprietary Class II with THD < 20% and PF > 0.9. 20kV/10kA surge protection per ANSI C136.2 – 2018 Extreme rating. Three-position terminal block with optional pigtailed. Separate electronics compartment is rated IP66.

Controls

Dimmable driver. 0-10V interface standard with 7-pin NEMA receptacle option. Manual wattage control (FAO) optional.

Custom packages include Photocontrol FailSafe™ and compatibility with the Bluetooth BLE ConnectLED™ mobile app. Can be combined with Evluma's integrated photocell, 3-pin, or 7-pin receptacles.

Warranty

Ten-year warranty.



ROADMAX

PRODUCT CONFIGURATIONS

SAMPLE NUMBER: RX1-050C3T2G0-S3HGL2-A0BN

FAMILY ID	WATTS	LED	CCT (K)	DISTRIBUTION	LENS	PCR /INTEGRATED/ FAILSAFE
RX1 = RoadMax small	030 = 30 040 = 40 050 = 50 060 = 60 070 = 70 080 = 80* 090 = 90* 100 = 100* * E output option only	C = standard output E = high output	7 = 2700 3 = 3000 4 = 4000 5 = 5000	T2 = type II T3 = type III T5 = type V	G0= none G1= diffused glare control	S3= 3 pin socket only S7= 7 pin socket only (0-10V) F3= S3 pin + Failsafe/CLED F7= S7 pin + Failsafe/CLED FP= Integrated P + Failsafe/CLED

HOUSING	LEADS	FEATURE CODE A	FEATURE CODE B
HG = standard gray HB = standard black HZ = standard bronze ZG = coastal gray ZB = coastal black ZZ = coastal bronze	L0 = none L6 = 6' L1 = 10' L2 = 20'	A0 = none AF = FAO (field-adjustable wattage selector)* *FP option (P + FailSafe) cannot be combined with the AF option (FAO)	B0 = none BN = NEMA label

Lenses

The primary glass RX1 lenses are designed to deliver precise, evenly-distributed light with a low veiling luminance for Type II, Type III and Type V distributions.

Choose G1 to add a secondary lens made from a specially formulated LED acrylic for exceptional glare control.

Photocell Receptacles

All photocell receptacles are rotatable. Wireless photocell not provided.

Integrated Photocell (P)

Evluma's integrated photocell shortens installation time. This UV-resistant, polycarbonate photocell meets FM 4473 impact resistance.

Photocontrol Failsafe™ (Failsafe)

Photocontrol Failsafe eliminates the need to replace failed photocells, saving truck-rolls. Combine this patented technology with S3, S7 receptacles or the P option. Packaged with ConnectLED.

ConnectLED™ (CLED)

Order the RX1 configured for compatibility with Evluma's ConnectLED app.

ConnectLED uses Bluetooth BLE technology to securely control individual luminaires. ConnectLED is available for as an Apple or Android app. Sold separately.

Field Adjustable Wattage Selector (FAO) Manually adjust luminaire wattage and lumen output in the field using the FAO. Seven output levels.

FAO SETTINGS

SWITCH POSITION	INPUT WATTS MULTIPLIER	DELIVERED LUMENS MULTIPLIER
A	100%	100%
B	88%	90%
C	74%	78%
D	60%	65%
E	46%	52%
F	34%	40%
G	22%	26%
H	22%	26%

Multiply the nominal wattage and/or lumens to arrive at reduced values. Typical accuracy is +/- 10%. Select the A position if using with an S7 receptacle and wireless node.

RX1 DIMENSIONS

19.81 in
50.33 cm

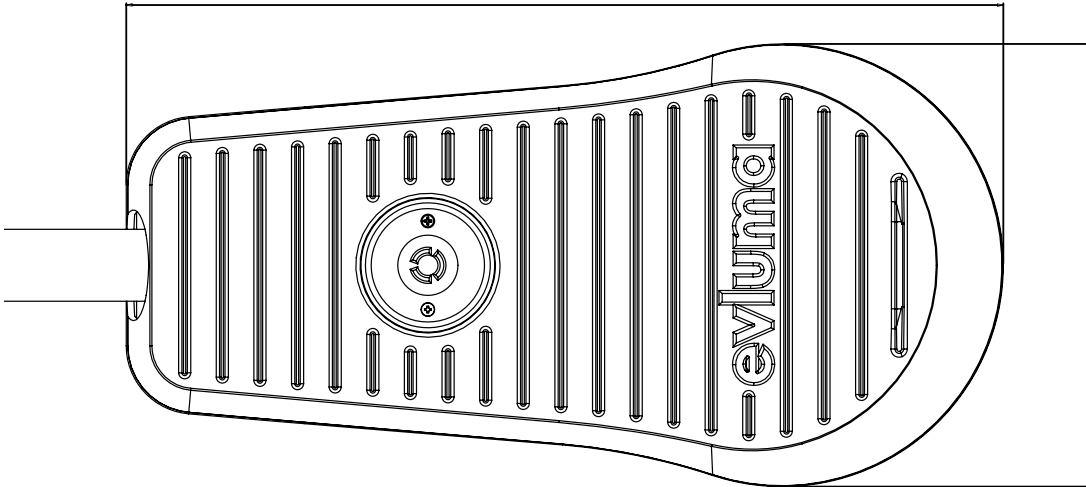

10 in
25.40 cm

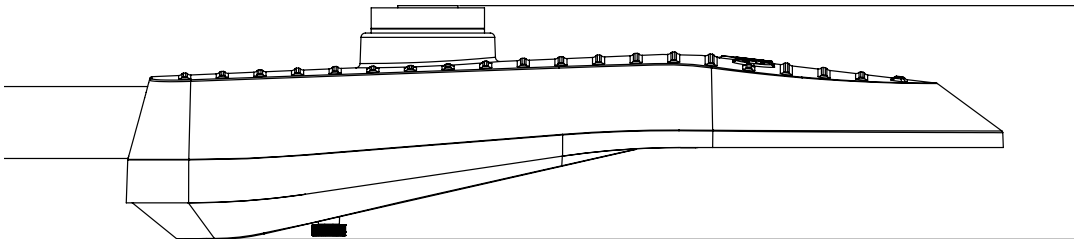

5.28 in
13.41 cm

TECHNICAL SPECS



Electrical Data

120-277 VAC 60 Hz.
THD <20% 120-277 VAC
PF >90% 120-277 VAC
Driver Lifetime >100,000 hrs
-40°C Min / 50°C Max Temp

Certification Data

UL 1598. MET Labs
IP66. IEC 60598-1
ASTM D2247-68 Humidity
ASTM B117-19 3,000hr
salt fog performance test
EPA under 0.5 sq ft

C136.31-2018
Level2/3G Vibration

ANSI C136.2-2018
20kV/10kA Surge

DLC 30-70W

Not all product variations listed on this datasheet are DLC qualified. Visit <https://qpl.designlights.org> to confirm qualification.

Any RX1 model with S3, but no FAO (A0) is not qualified under DLC 5.1 as these models are not capable of continuous dimming. Example RX1-XXXXXXXX-S3XXXX-A0XX.

Dark Sky Approved

Multiple RX1 models have received the IDA Dark Sky Seal of Approval. darksky.org.

Models offered in 3000K (3) or 2700K (7) are IDA approved. All RX1 are U0.

Community Friendly Lighting (SOLA) Certified

Models offered in 3000K and 2700K measuring U0 are also CFL SOLA Certified. volt.org.

3K = 16% SPD <530nm
27K = 17% SPD <530nm

Shipping

Single unit Weight = 8lbs

LTL pallet qty 42
FTL pallet qty 30
FTL qty 840

LENS ACCESSORIES

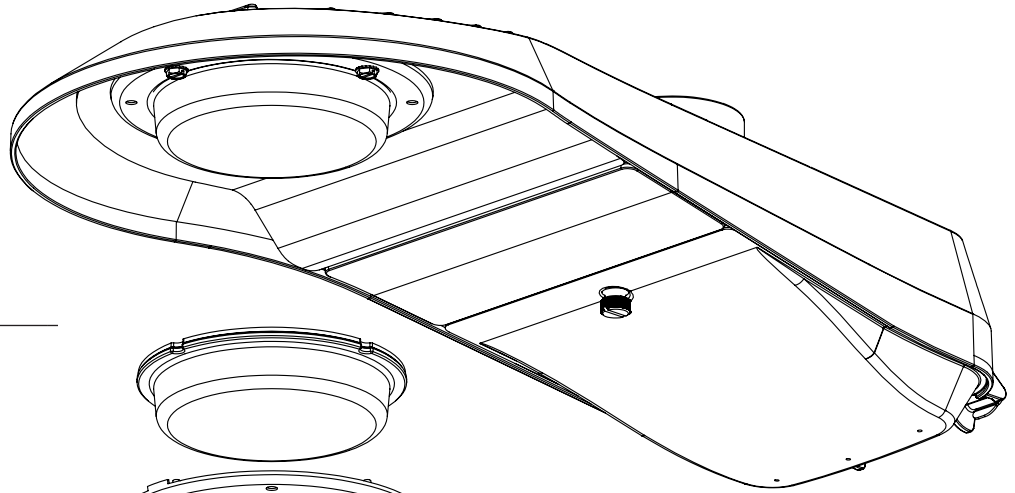

SECONDARY LENS FOR GLARE CONTROL

Push Veiling Luminance even lower while maintaining competitive pole spacing within RP-8-21 recommendations.

RX1 can be ordered from the factory with a secondary lens installed for additional glare control, or order separately for installation in the field at a later date.

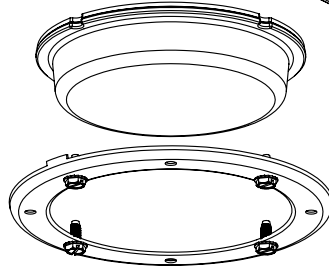

RX1-LENSG1

Prioritize glare reduction while maintaining high roadway performance.

The glare control lens is made from a specially formulated optical acrylic for use with LEDs. Coastal version available. To order separately see the catalog number below.

FAMILY ID	STYLE	COLOR
RX1	LENSG1 = secondary lens for glare control	HG = standard gray HB = standard black HZ = standard bronze ZG = coastal gray ZB = coastal black ZZ = coastal bronze

LIGHT TRESPASS SHIELDS

Reduce light trespass and discomfort glare. Field installable shields can be mounted over primary optic or secondary lens and in any position - front, back or sides. Shields maintain No Uplight (U0) rating and add no additional EPS. Coastal version available.

FAMILY ID	STYLE	COLOR
RX1	LTS1 = house-side shield (large) LTS2 = front-side shield (small)	HG = standard gray HB = standard black HZ = standard bronze ZG = coastal gray ZB = coastal black ZZ = coastal bronze

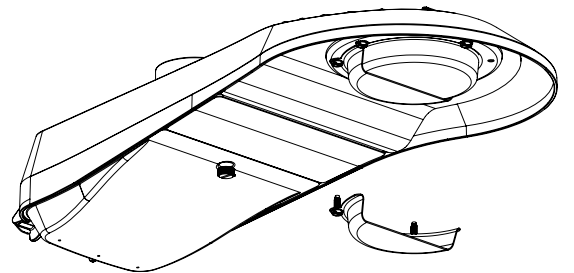

RX1-LTS1
house-side shield

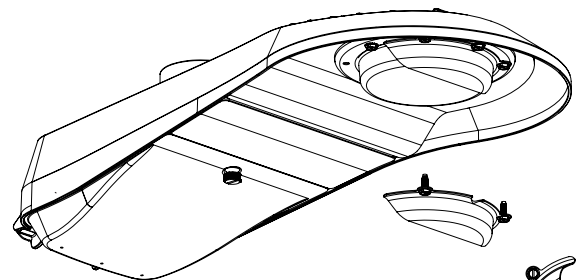
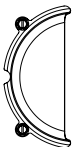

RX1-LTS2
front-side shield

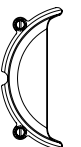

PERFORMANCE 30-70W

C Standard Output LED

Nominal lumen values reported. Individual fixtures may vary +- 10%. IES files available at evluma.com

WATTAGE	DISTRIBUTION Type, Lm/W & BUG	LUMENS (all CCT = >70 CRI)							
		G0 option - primary lens				G1 option - glare control			
		2700K	3000K	4000K	5000K	2700K	3000K	4000K	5000K
30	II	3420	3780	3930	3960	3030	3360	3480	3500
	Lm/W	114	126	131	132	101	112	116	117
	BUG	B1-U0-G1	B1-U0-G1	B1-U0-G1	B1-U0-G1	B1-U0-G1	B1-U0-G1	B1-U0-G1	B1-U0-G1
	III	3510	3900	3990	4030	3120	3450	3550	3560
	Lm/W	117	130	133	134	104	115	118	119
	BUG	B1-U0-G1	B1-U0-G1	B1-U0-G1	B1-U0-G1	B1-U0-G1	B1-U0-G1	B1-U0-G1	B1-U0-G1
	V	3780	4200	4350	4380	3300	3690	3780	3840
	Lm/W	126	140	145	146	110	123	126	128
	BUG	B2-U0-G1	B2-U0-G1	B2-U0-G1	B2-U0-G1	B2-U0-G1	B2-U0-G1	B2-U0-G1	B2-U0-G1
40	II	4440	5000	5120	5160	3960	4400	4520	4550
	Lm/W	111	125	128	129	99	110	113	114
	BUG	B1-U0-G1	B1-U0-G1	B1-U0-G1	B1-U0-G1	B1-U0-G1	B1-U0-G1	B1-U0-G1	B1-U0-G1
	III	4520	5080	5230	5270	4040	4480	4610	4630
	Lm/W	113	127	131	132	101	112	115	116
	BUG	B1-U0-G1	B1-U0-G1	B1-U0-G1	B1-U0-G1	B1-U0-G1	B1-U0-G1	B1-U0-G1	B1-U0-G1
	V	4920	5440	5640	5680	4320	4800	4920	4960
	Lm/W	123	136	141	142	108	120	123	124
	BUG	B3-U0-G1	B3-U0-G1	B3-U0-G1	B3-U0-G1	B2-U0-G1	B2-U0-G1	B2-U0-G1	B2-U0-G1
50	II	5450	6100	6250	6300	4850	5400	5550	5600
	Lm/W	109	122	125	126	97	108	111	112
	BUG	B1-U0-G1	B1-U0-G1	B1-U0-G1	B1-U0-G1	B1-U0-G1	B1-U0-G1	B1-U0-G1	B1-U0-G1
	III	5550	6200	6400	6450	4950	5500	5680	5700
	Lm/W	111	124	128	129	99	110	114	114
	BUG	B1-U0-G1	B1-U0-G1	B1-U0-G1	B1-U0-G1	B1-U0-G1	B1-U0-G1	B1-U0-G1	B1-U0-G1
	V	5850	6500	6700	6750	5300	5900	6050	6100
	Lm/W	117	130	134	135	106	118	121	122
	BUG	B3-U0-G1	B3-U0-G1	B3-U0-G1	B3-U0-G1	B3-U0-G1	B3-U0-G1	B3-U0-G1	B3-U0-G1
60	II	6420	7080	7320	7380	5700	6300	6480	6540
	Lm/W	107	118	122	123	95	105	108	109
	BUG	B1-U0-G1	B1-U0-G1	B1-U0-G1	B1-U0-G1	B1-U0-G1	B1-U0-G1	B1-U0-G1	B1-U0-G1
	III	6540	7260	7500	7560	5820	6480	6680	6720
	Lm/W	109	121	125	126	97	108	111	112
	BUG	B1-U0-G1	B1-U0-G1	B2-U0-G2	B2-U0-G2	B1-U0-G1	B1-U0-G2	B1-U0-G2	B1-U0-G2
	V	6900	7620	7860	7920	6240	6900	7140	7200
	Lm/W	115	127	131	132	104	115	119	120
	BUG	B3-U0-G1	B3-U0-G1	B3-U0-G1	B3-U0-G2	B3-U0-G1	B3-U0-G1	B3-U0-G1	B3-U0-G1
70	II	7210	7980	8260	8330	6440	7140	7390	7430
	Lm/W	103	114	118	119	92	102	106	106
	BUG	B1-U0-G1	B1-U0-G2	B1-U0-G2	B1-U0-G2	B1-U0-G1	B2-U0-G1	B2-U0-G1	B2-U0-G1
	III	7210	7980	8260	8320	6370	7070	7280	7350
	Lm/W	103	114	118	119	91	101	104	105
	BUG	B1-U0-G1	B2-U0-G2	B2-U0-G2	B2-U0-G2	B1-U0-G1	B1-U0-G2	B2-U0-G2	B2-U0-G2
	V	7770	8610	8890	8960	6790	7560	7770	7840
	Lm/W	111	123	127	128	97	108	111	112
	BUG	B3-U0-G1	B3-U0-G2	B3-U0-G2	B3-U0-G2	B3-U0-G1	B3-U0-G2	B3-U0-G2	B3-U0-G2



Visit <https://qpl.designlights.org> to confirm qualification.
Not all product variations are DLC qualified.

PERFORMANCE 80-100W

E High Output LED

Nominal lumen values reported. Individual fixtures may vary +/- 10%. IES files available at evluma.com

WATTAGE	DISTRIBUTION Type, Lm/W & BUG	LUMENS (all CCT = >70 CRI)							
		G0 option - primary lens				G1 option - glare control			
		2700K	3000K	4000K	5000K	2700K	3000K	4000K	5000K
80	II	8640	9680	9900	9950	7600	8480	8640	8720
	Lm/W	108	121	124	125	95	106	108	109
	BUG	B2-U0-G1	B2-U0-G2	B2-U0-G2	B2-U0-G2	B2-U0-G1	B2-U0-G2	B2-U0-G2	B2-U0-G2
	III	8720	9760	9920	10000	7680	8560	8640	8720
	Lm/W	109	122	124	125	96	107	108	109
	BUG	B2-U0-G2	B2-U0-G2	B2-U0-G2	B2-U0-G2	B2-U0-G2	B2-U0-G2	B2-U0-G2	B2-U0-G2
	V	9280	10400	10640	10720	8160	9120	9360	9440
	Lm/W	116	130	133	134	102	114	117	118
	BUG	B3-U0-G1	B3-U0-G1	B3-U0-G2	B3-U0-G2	B3-U0-G1	B3-U0-G2	B3-U0-G2	B3-U0-G2
90	II	9360	10440	10710	10800	8190	9090	9360	9450
	Lm/W	104	116	119	120	91	101	104	105
	BUG	B2-U0-G2	B2-U0-G2	B2-U0-G2	B2-U0-G2	B2-U0-G2	B2-U0-G2	B2-U0-G2	B2-U0-G2
	III	9450	10530	10800	10890	8280	9180	9450	9540
	Lm/W	105	117	120	121	92	102	105	106
	BUG	B2-U0-G2	B2-U0-G2	B2-U0-G2	B2-U0-G2	B2-U0-G2	B2-U0-G2	B2-U0-G2	B2-U0-G2
	V	10350	11520	11790	11880	9000	9990	10260	10350
	Lm/W	115	128	131	132	100	111	114	115
	BUG	B3-U0-G1	B3-U0-G2	B3-U0-G2	B3-U0-G2	B3-U0-G1	B3-U0-G2	B3-U0-G2	B3-U0-G2
100	II	10000	11200	11500	11600	8800	9900	10100	10200
	Lm/W	100	112	115	116	88	99	101	102
	BUG	B2-U0-G2	B2-U0-G2	B2-U0-G2	B2-U0-G2	B2-U0-G2	B2-U0-G2	B2-U0-G2	B2-U0-G2
	III	10200	11300	11600	11700	9000	9900	10200	10300
	Lm/W	102	113	116	117	90	99	102	103
	BUG	B2-U0-G2	B2-U0-G2	B2-U0-G2	B2-U0-G2	B2-U0-G2	B2-U0-G2	B2-U0-G2	B2-U0-G2
	V	11300	12600	12900	13000	9700	10900	11100	11200
	Lm/W	113	126	129	130	97	109	111	112
	BUG	B3-U0-G2	B3-U0-G2	B3-U0-G2	B3-U0-G2	B3-U0-G2	B3-U0-G2	B3-U0-G2	B3-U0-G2



3600 Lind Avenue SW Suite 140
Renton WA 98057
425-336-5800 www.evluma.com

TP-0068-A04

Copyright © 2023 Express Imaging Systems, LLC. Evluma, RoadMax, ConnectLED, and Photocontrol Failsafe are trademarks of Express Imaging Systems, LLC. All rights reserved. Content is subject to change. For informational purpose only. MET labs logo is a registered trademark of MET labs.